

PPC 2540 Projector ceiling mount

Article number (SKU) 7025404
 Colour Silver

Key benefits

- Cables fully concealed
- Fine tuning during installation
- Theft prevention
- TÜV certified

The PPC 2540 is a height adjustable projector mount specially designed for the latest generation of projectors weighing up to 25 kg. This projector interface is equipped with fine tune adjustability for precise alignment to the projection surface. Once aligned, the projector stays in position. Turning the unique friction ring will eliminate all play from the interface connections, making the mount a solid and very stable solution.

The height adjustable projector ceiling mount kits can be used when the height of the ceiling is not known or when flexibility is wanted. These mounts come in 3 lengths offering variable height adjustment from 400 to 1350 mm. The Cable Inlay System runs the full length of the pole and even allows for cable routing after installation. The offers sufficient space for all cables required and enables you to hide all the cables in a matter of seconds.

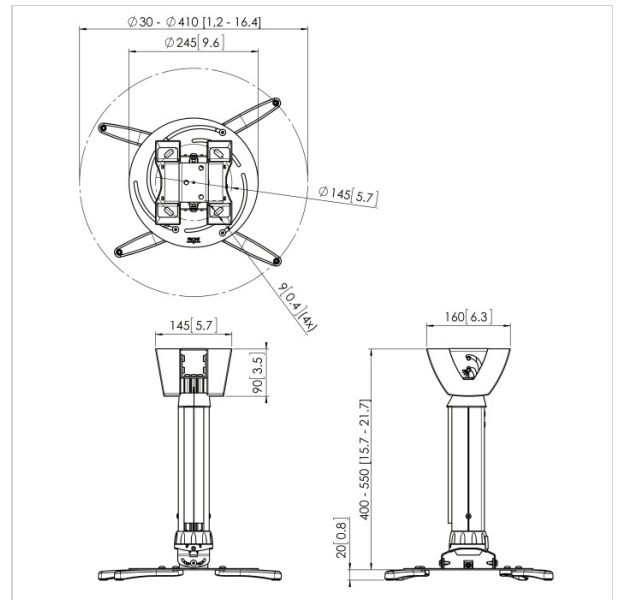

PPC 2540 Projector ceiling mount

www.vogels.com

VOGEL'S HOLDING BV 2017 (c) All rights reserved
Subject to printing errors, technical and price
amendments
Date: 16-10-2017

Specifications

Product specifications

Product type number	PPC 2540
Article number (SKU)	7025404
Colour	Silver
EAN single box	8712285325243
Tilt	Tilt up to 15°
Turn	Up to 360°
Roll	15
Guarantee	5 years
Max. weight load (kg)	25

Features

Range (diameter)	30 - 410 mm
---------------------	----------------

Technical specifications and dimensions

Min. distance to ceiling (mm)	400
Max. distance to ceiling (mm)	550

